

DC Film Capacitors

Please refer to our Internet address (<http://www.arcotronics.com>) for updated information on Arcotronics products, services and news.

Contents	Pitch mm	Rated Voltage Vdc range	Capacitance range	Page
General Information				2 to 19
Technical terms explanation				2
Application notes - safety conditions				3
Typical properties and applications				13
Typical graphs				13
Product code system and date code				14
Lead taping & packaging				15
Polyester capacitors				21 to 65
Contents				21
Typical graphs				22
Axial series				23 to 27
A50 Series		50...1000	1000pF...10µF	23
Box series				28 to 57
R82 Series	5	50...400	1000pF...4.7µF	28
RSB Series	5	50...630	1000pF...2.2µF	33
R66 Series	7.5	50...630	1000pF...4.7µF	38
R60 Series	10...37.5	63...1000	1000pF...220µF	43
JSP Series	22.5...37.5	63...400	0.33µF...470µF	51
Naked series				58 to 65
JSN Series	(Size) 60.80...100.230	63...400	5µF...330µF	58
Polypropylene capacitors				67 to 143
Contents				67
Typical graphs				68
Axial series				70 to 79
A70 Series		160...630	1000pF...4.7µF	70
A72 Series		100...2000	47pF...0.33µF	75
Box series				80 to 143
R73 Series	15...37.5	100...2000	100pF...2.2µF	80
R74 Series	10...37.5	250...900 Vac	470pF...3.3µF	90
R75 Series (High performances)	7.5...37.5	160...2000	220pF...33µF	102
R75 Series (Reduced sizes)	7.5...37.5	160...1000	0.010µF...22µF	113
R76 Series	7.5...37.5	250...2000	100pF...15µF	121
R77 Series	10...27.5	250...900Vac	1000pF...0.1µF	133
R79 Series	5	160...630	1000pF...0.22µF	139
Precision capacitors				145 to 150
Contents				145
Typical graphs				146
Box series				147 to 150
P12 (P02) Series	5.08	63	22pF...8000pF	147
P14 (P04) Series	5.08	63	5000pF...47000pF	148
P42 Series	7.18...14.3	63	100pF...432000pF	149
Interference Suppression capacitors, RC units, P.F.C., Capacitive power supply application and Modules				151 to 193
Contents				151
Short guide to choose the right film capacitor used in series with the main				152
Information on International Standards - Tests related to IEC 60384-14 (EN132400)				154
Typical graphs and date code				157
Interference suppression				158 to 179
Box series				158 to 179
R.46 Series	10...37.5	275...300 Vac	0.01µF...10µF	158
R.47 Series	10...37.5	440 Vac	4700pF...2.2µF	167
R.49 Series	10...37.5	310 330 Vac	0.01µF...6.8µF	173
R.41 Series	7.5...37.5	300 Vac	1000pF...1µF	177
RC units				179
Box series				179
1.43 Series	15...27.5	275 Vac	0.01µF...1µF	179
P.F.C.				180 to 184
Box series				180
R71 Series	10...37.5	420...630	0.01µF...22µF	180
Capacitive power supply application				185 to 189
Box series				185
R752-R75L	15...37.5	230...250 Vac	0.056µF...10µF	185
R603	22.5...37.5	300 Vac	0.15µF...6.8µF	188
Modules				190 to 193
Box series				190
F5A Series	5...10	5...63	0.1µF...3.3µF	190
F5B Series	5...10	5...63	0.1µF...3.3µF	192

TECHNICAL TERMS EXPLANATION

Rated capacitance

Capacitance referred to 1 kHz, 20±1°C, 65±2% of relative humidity and 96 ±10 kPa.

In case of doubt please refer to IEC 60068-1, sub-clause 5.2.

Capacitance tolerance

Admitted capacitance deviation from the rated capacitance.

Rated temperature (T_R)

The maximum ambient temperature surrounding the capacitor or hottest contact point (e.g. tracks), whichever is higher, at which the rated voltage V_{dc} or V_{ac} at 50 Hz may be continuously applied.

Rated voltage (V_R)

The maximum direct voltage or the maximum r.m.s. alternating voltage (50 Hz) or the peak value of a pulse voltage which may be continuously applied to a capacitor at any temperature between the lower category temperature and the rated temperature.

Category voltage (V_c)

The maximum direct voltage or the maximum r.m.s. alternating voltage or the peak value of a pulse voltage which may be continuously applied to a capacitor at its upper category temperature.

Temperature derated voltage

The maximum voltage that may be continuously applied to a capacitor for any temperature between the rated temperature and the upper category temperature.

Climatic category

The climatic category which the capacitor belongs to is expressed in numbers (standard IEC 60068-1: example 55/100/56).

The first number represents the lower category temperature (example: -55°C); the second number the upper category temperature (example: +100°C) and the third number represents the number of days relevant to the damp heat test (example: 56 days).

Operating temperature range

The operating temperature of the capacitor is defined as the ambient temperature + self temperature raise + temperature raise due to thermal radiation from other heat sources.

Temperature coefficient of capacitance (α_c)

The change rate of capacitance with temperature measured over a specified range of temperature. It is normally expressed in parts per million per Celsius degree (10⁻⁶/°C) and referred to 20°C

$$\alpha_c = \frac{C_i - C_o}{C_o (T_i - T_o)} \quad \text{where: } C_i = \text{Capacitance at temperature } T_i \\ C_o = \text{Capacitance at temperature } 20 \pm 2^\circ\text{C}$$

For more details please refer to EN 130000.

Variation of capacitance with humidity

The capacitance of a plastic film capacitor changes with the ambient humidity. The capacitance change depends upon the dielectric type. Please refer to the graph at page 12.

Dissipation factor (tgδ)

The dissipation factor is the ratio between the resistive and the reactive part of the impedance of the capacitor submitted to a sinusoidal voltage of specified frequency.

Insulation resistance (I_r) / time constant

The insulation resistance is the ratio between an applied D.C. voltage and the resulting leakage current after a minute of charge. It is expressed in MΩ. The time constant is expressed in seconds with the following formula:

$$t [\text{s}] = I_r [\text{M}\Omega] \times C [\mu\text{F}]$$

It states the time necessary to reduce the voltage to the terminals of the capacitor at 37% of a fully charged capacitor value.

Pulse rise time (dv/dt) and K₀

The pulse rise time defines the capability of a capacitor to withstand high current peaks due to fast voltage changes.

The peak current is defined by the following formula:

$$I_p (\text{peak current}) = C \times dv/dt$$

where: I_p in A; C in μF; dv/dt in V/μs

K₀ is the content of energy of the wave-form applied to the capacitor and it is defined by the following formula:

$$K_0 = 2 \int_0^\tau (dv/dt)^2 dt$$

where: τ (pulse width) in μs; K₀ in V²/μs.

The maximum values of dv/dt and K₀ mentioned in this catalogue must not be exceeded in order to prevent a dangerous overheating of the capacitor.

APPLICATION NOTES - SAFETY CONDITIONS

1. Operating voltage

1.1 Rated voltage (V_R)

Rated voltage is the max voltage that may be continuously applied at the rated temperature. Values higher than the rated voltage may cause a perforation in the capacitor dielectric or a short circuit.

Metallized capacitors have self-healing properties and the application of voltages higher than rated voltage will not cause an immediate short circuit. Instead, what may occur, is a progressive drop in the insulation resistance with a possible risk of smoke or fire, depending upon the type of electric circuit in which the capacitor is working.

The rated voltage of the capacitor is usually D.C.

If a capacitor marked D.C. is used as an A.C. capacitor, the maximum working voltage is limited by the heat produced or by micro discharges that could take place inside the capacitor. Do not use A.C. voltages higher than those specified in the catalogue for each series.

Note:

- a) The A.C. voltages described in the catalogue refer to a sinusoidal wave-form. In case of other types of waveforms or for working conditions different from those described in the catalogue, please contact our Technical Service before using the capacitors.
- b) If the capacitor is subject to voltages higher than the rated voltage, caused, for example, by the bad functioning of other equipment, it might be necessary to use a protection device.
- c) The Rated Voltage (V_{ac}) can be applied during the whole life of the capacitor in case you are using a suppressor series or those quoting "A.C. APPLICATIONS".
In any other case, the V_{ac} can be applied for a max. operating time of 1000 hours.

1.2 Derating of rated voltage for high operating temperature

In case of a plastic film capacitor, the operating temperature (the temperature measured on the hottest point of the capacitor) depends upon the type of dielectric used, the ambient temperature in which the capacitor is placed, the type of voltage applied (A.C. or D.C.) and in case of pulse applications, upon the value of current and frequency applied.

The rated voltage (V_R) is the maximum voltage that can be applied at a temperature \leq the rated temperature.

For temperatures higher than the rated temperature it is necessary to apply a voltage derating to prevent any damages to the dielectric of the capacitor.

This derating depends, in general, upon the type of dielectrics used (polyester, polypropylene, etc.).

The catalogue quotes the limits for each series.

2. Dissipation (A.C. applications)

When a capacitor is used in A.C. applications at high frequency, internal heating of the capacitor may follow with a possible risk of smoke or fire. This is caused by the heating effect of the current flowing through the internal resistance of the capacitor. The formula used to calculate the max power dissipated by the capacitor is the following:

$$P_{cmax} = \sum_1^N V_{rmsc_i}^2 \times 2\pi f_i \times C \times tg\delta_{max}(f_i) = \sum_1^N \frac{I_{rmsc_i}^2}{2\pi f_i \times C} \times tg\delta_{max}(f_i)$$

where:

- P_{cmax} = max dissipated power in watt
- V_{rmsc_i} = r.m.s. voltage of the i^{th} harmonic in volt
- I_{rmsc_i} = r.m.s. current of the i^{th} harmonic in ampere
- f_i = frequency of the i^{th} harmonic in hertz
- C = capacitance in farad
- $tg\delta_{max}(f_i)$ = max. dissipation factor corresponding to the frequency of the i^{th} harmonic
- N = number of significant harmonics

V_{rmsc_i} (I_{rmsc_i}) is related to V_{pp} (I_{pp}) as shown in Fig. 2 at page 8.

In case of sinusoidal wave-form ($N = 1$) the formula to calculate P_{cmax} becomes:

$$P_{cmax} = V_{rmsc}^2 \times 2\pi f \times C \times tg\delta_{max}(f) = \frac{I_{rmsc}^2}{2\pi f \times C} \times tg\delta_{max}(f)$$

(to calculate the P_{cmax} for some typical wave-forms, it is possible to use the approximate formulas of V_{rmsc} and I_{rmsc} listed in the table 1 at page 5).

- ΔT_{lim} = allowed capacitor overtemperature in °C.
- T_h = max. ambient temperature surrounding the capacitor or hottest contact point (e.g. tracks), whichever is higher, in the worst operation conditions in °C.

Box Type

For $T_h \leq 40^\circ C$

$\Delta T_{lim} = 40^\circ C$ for film-foil polypropylene capacitors (KP), polypropylene capacitors with double sided metallized film electrodes (MMKP), metallized polyester film capacitors (MKT).

$\Delta T_{lim} = 20^\circ C$ for polypropylene capacitors with single sided metallized film electrodes (MKP).

The outline of ΔT_{lim} vs. T_h is represented in the graph at page 6.

The formula used to calculate the max. power that may be dissipated by the capacitor is:

$$P_{clim} = \frac{\Delta T_{lim}}{R_{th}}$$

where:

- P_{clim} = maximum power that may be dissipated by the capacitor in W
- R_{th} = thermal resistance of the capacitor in °C/W (see table 2 at page 5).
- ΔT_{lim} = allowed capacitor overtemperature in °C

It must be:

$$P_{cmax} \leq P_{clim}$$

In case of a sinusoidal wave-form the graphs of $V(f)$ are illustrated in the pages of the catalogue relative to each series.

Warning:

apart from the derating of the voltage versus the working frequency it is also necessary to consider the derating of the voltage versus the working temperature (see paragraph 1.2). Do not hesitate to contact our Technical Service for any doubts or more detailed information.

Table 1

WAVE-FORM	ELECTRICAL PARAMETERS
<p>FLY-BACK</p>	$V_{\text{rmsc}} = \frac{V_{\text{pp}}}{1.04} \sqrt{\frac{t}{2T}}$ $I_{\text{rmsc}} = \frac{I_{\text{pp}}/2}{1.04} \sqrt{\frac{t}{2T}}$ $f = \frac{1}{2t}$ $\text{tg}\delta_{\text{max}} \text{ at } f = \frac{1}{2t}$
<p>S-CORRECTION</p>	$V_{\text{rmsc}} = \frac{V_{\text{pp}}}{2\sqrt{2}}$ $I_{\text{rmsc}} = \frac{I_{\text{pp}}}{2\sqrt{2}}$ $f = \frac{1}{T}$ $\text{tg}\delta_{\text{max}} \text{ at } f = \frac{1}{T}$
<p>DAMPED OSCILLATION</p>	$V_{\text{rmsc}} = \sqrt{\sum_{i=1}^8 \frac{V_i^2}{2} \frac{t}{2T}}$ $I_{\text{rmsc}} = \sqrt{\sum_{i=1}^8 \frac{I_i^2}{2} \frac{t}{2T}}$ $f = \frac{1}{t}$ $\text{tg}\delta_{\text{max}} \text{ at } f = \frac{1}{t}$
<p>TRAPEZOIDAL</p>	$V_{\text{rmsc}} = V_{\text{pp}} \sqrt{\frac{3T-4t}{12T}}$ $f = \frac{1}{T}$ $\text{tg}\delta_{\text{max}} \text{ at } f = \frac{1}{4t}$

Note: For axial type see page 6.

Table 2

Pitch	Box			R _{th}
	B	H	L	
(mm)	(mm)			(°C/W)
5.0	2.5	6.5	7.2	127
	3.5	7.5	7.2	111
	4.5	9.5	7.2	94
	5.0	10.0	7.2	90
	6.0	11.0	7.2	82
7.5	7.2	13.0	7.2	73
	2.5	7.0	10.0	107
	3.0	8.0	10.0	98
	3.5	6.5	10.5	100
	3.5	8.5	10.5	91
	4.0	9.0	10.5	86
10.0	5.0	11.0	10.5	75
	6.0	12.0	10.5	69
	4.0	9.0	13.0	79
15.0	5.0	11.0	13.0	69
	6.0	12.0	13.0	64
	4.0	10.0	18.0	65
	5.0	11.0	18.0	60
	6.0	12.0	18.0	56
	7.5	13.5	18.0	51
	6.0	17.5	18.0	48
	7.5	14.5	18.0	49
	8.5	14.5	18.0	48
	9.0	12.5	18.0	50
	7.5	18.5	18.0	45
22.5	10.0	16.0	18.0	44
	13.0	12.0	18.0	45
	11.0	19.0	18.0	40
	6.0	15.0	26.5	43
	6.5	13.5	26.5	44
	7.0	16.0	26.5	41
27.5	8.5	17.0	26.5	38
	10.0	18.5	26.5	36
	11.0	20.0	26.5	34
	13.0	22.0	26.5	31
	9.0	17.0	32.0	35
	10.0	20.0	32.0	32
	11.0	20.0	32.0	31
	13.0	22.0	32.0	29
37.5	13.0	25.0	32.0	28
	14.0	28.0	32.0	26
	15.0	24.5	32.0	27
	18.0	33.0	32.0	23
	22.0	37.0	32.0	21
	11.0	22.0	41.5	27
	13.0	24.0	41.5	25
	16.0	28.5	41.5	23
	19.0	32.0	41.5	21
20.0	40.0	41.5	19	
24.0	44.0	41.5	17	
30.0	45.0	41.5	16	

Maximum Overtemperature ΔT_{lim} vs. T_h for Box Type

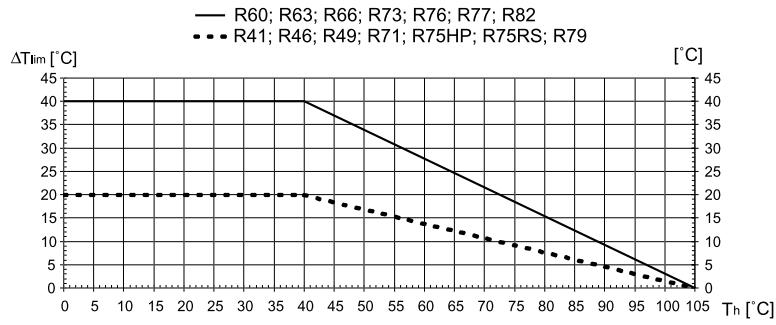

— RSB

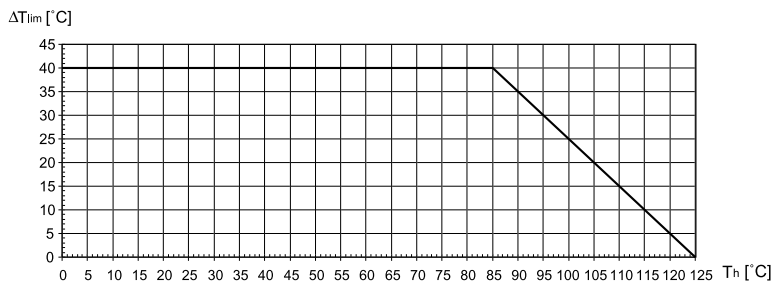

— R74

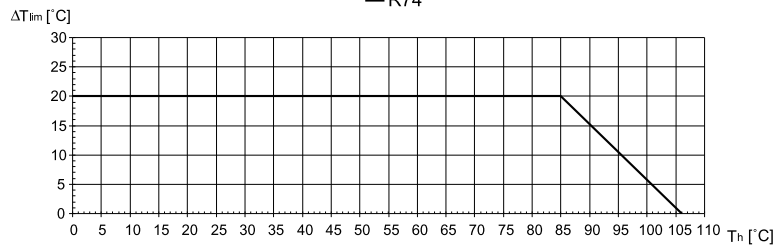

Maximum Self-heating rise for series in Axial configuration.

Series	Costruction	Configuration	Maximum ambient Temperature	Maximum Self Temperature rise
A50	MKT	Axial	85°C	10°C
A70	MKP	Axial	85°C	10°C
A72	MKP Film foil	Axial	85°C	10°C

3. Permissible current

The main effect produced by the current flowing through the capacitor is overheating. If the heating is excessive, the capacitor might deteriorate, which could cause a short or open circuit of the capacitor or a fire.

The heating of the capacitor can be caused by two different types of currents:

3.1 Effective current (r.m.s. current) given by a periodic wave-form, causing the entire body of the capacitor to heat up.

3.2 Peak of current caused by a pulse wave-form.

- When a medium-high current pulse flows through the capacitor for a very short time ($\mu\text{s}/\text{ns}$), a localized heating of the ends of the capacitor might take place due to the resistance of the contacts between the leads and end spray and between the end spray and the electrodes of the capacitor.

These conditions usually take place mainly in the following type of circuits: switching, snubber, fly-back and S-correction.

- The parameters that define this type of phenomenon are dv/dt (pulse rise time) and K_0 .

The pulse rise time defines the capability of a capacitor to withstand high current peaks due to fast voltage changes. The peak current is defined by the following formula:

$$I_p \text{ (peak current)} = C \times dv/dt$$

where: I_p in A; C in μF ; dv/dt in $\text{V}/\mu\text{s}$

K_0 is the content of energy of the wave-form applied to the capacitor and it is defined by the following formula:

$$K_0 = 2 \int_0^\tau (dv/dt)^2 dt$$

where: τ = pulse width. K_0 is expressed in $\text{V}^2/\mu\text{s}$.

The maximum values of dv/dt and K_0 mentioned in this catalogue must not be exceeded in order to prevent a dangerous overheating of the capacitor.

If more than 10,000 pulses are applied, please kindly contact our Technical Service, unless you are using series A72, R73, R74, R75, R76, R77, R79, RSB.

Warning:

If the capacitor is subjected to r.m.s. and pulse currents higher than those admitted, caused for example by a bad functioning of any other equipment, we suggest the use of a protection device.

4. Operating temperature

4.1 ΔT (overtemperature of a capacitor).

As described in the previous paragraphs, when a capacitor is used in A.C. applications the current that flows through the capacitor makes it heat up. If the capacitor heats up too much it might deteriorate causing a short circuit or fire. It is essential that the limits described in the catalogue are not exceeded and that a temperature check on the capacitor is made whenever it is under heavy load.

4.2 Method for determining the overtemperature (ΔT_m) of the capacitor (indicative only).

Figure 1 shows the test lay-out.

The measurement must be made in free air convection. The capacitor being tested must be supplied by the working voltage (V_{ac}) and frequency (f). At a distance of about 50 mm it is necessary to place another capacitor (without any electric supply) on which the ambient temperature (T_2) is measured.

A polystyrene paper is placed between the p.c.b. on which the capacitor is fitted and the capacitor itself.

The temperature (T_1) must be measured in the hottest part of the capacitor being tested by using a thermocouple with a small heating capacity ($\varnothing < 0.25$ mm) or an infrared thermometer.

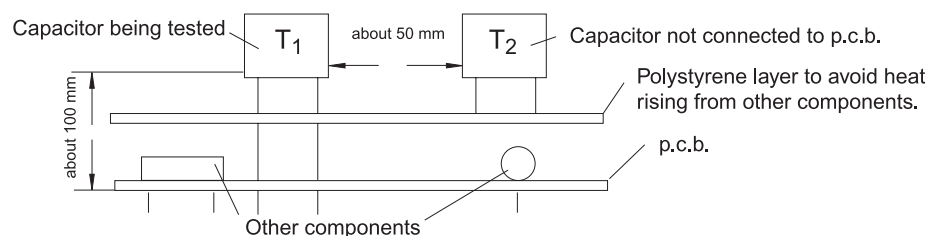

Fig. 1

$$\Delta T_m = T_1 - T_2$$

4.3 How to calculate the max. ΔT of the capacitor.

To calculate the max. ΔT of the capacitor use the following formula:

$$\Delta T_{max} = \frac{\Delta T_m}{\text{tg}\delta_m} \times \text{tg}\delta_{max}$$

where:

ΔT_{max} = capacitor overtemperature calculated using the max $\text{tg}\delta$ value at the working frequency.

ΔT_m = $T_1 - T_2$ (see paragraph 4.2).

$\text{tg}\delta_m$ = dissipation factor of the tested capacitor measured at the working frequency and at the temperature reached by the capacitor under test.

$\text{tg}\delta_{max}$ = max. dissipation factor at the working frequency of the capacitor under test (if this value is not available at catalogue, please contact us).

4.4 When using the capacitors, make sure that the ΔT_{max} of the capacitor (own overtemperature), calculated as described in paragraph 4.3, remains within the limits listed in paragraph 2 ($\Delta T_{max} \leq \Delta T_{lim}$).

Warning:

When a capacitor is used above its max. operating temperature, the dissipation factor ($\text{tg}\delta$) increases and consequently the heat generated by the capacitor itself. Temperatures exceeding the maximum admitted value might cause a damage of the dielectric, a short circuit or an increase in the risk of fire or smoke.

The same effects might be caused by other components or parts of the circuit that produce heat and cause localized heatings of the capacitor beyond its performance limits. In this case we suggest to check the temperature of the hottest point of the capacitor subject to the heat produced by the other components.

5. Ionisation

Ionisation may lead to a destructive process of the capacitor.

This phenomenon is due to the air that is inside the capacitor and precisely:

- the air contained inside the dielectric
- the air present in between the different layers of film that form the capacitor
- the air present near the ends of the capacitor

When the intensity of the electric field that is formed in a capacitor exceeds the dielectric rigidity of the air, some microdischarges might take place that could damage the dielectric of the capacitor and/or the metallization itself.

This phenomenon causes a drop in the capacitance and in the case of persistent ionization it may give rise to a short circuit or fire.

The voltage at which the ionization phenomenon is started is called corona inception voltage.

The size of the phenomenon depends upon certain factors such as:

- the amount of air contained in the capacitor
- the type of dielectric used
- impregnating elements (if used)
- the type of electrode (metallized film, film-foil)
- the type of construction (radial, axial)
- the construction parameters (i.e. element flattening)
- the temperature, voltage, working frequency

For a proper use of the capacitor, always make sure that the following condition is satisfied:

$$V_{pp} \text{ (peak to peak voltage)} \leq 2 \times \sqrt{2} \times V_R \text{ (a.c.)}$$

6. Pulse applications

In case of pulse applications it is necessary to follow these rules that must be considered as the minimum condition to be satisfied to prevent any damages to the capacitor itself and consequently to the circuit and to the equipment the capacitor has been fitted to:

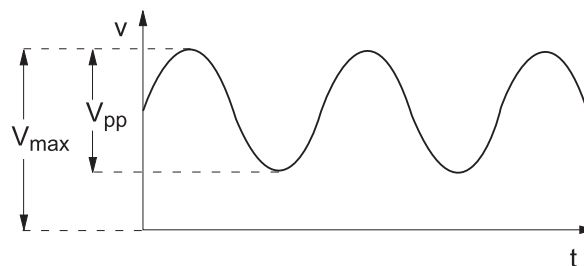

Wave-form characteristics (Fig. 2)	Capacitor characteristics involved	Choice criteria
V_{max} (max. voltage)	Dielectric strength	$V_{max} \leq V_R \text{ (d.c.)}$
V_{pp} (peak to peak voltage)	Corona Offset Voltage	$V_{pp} \leq 2 \times \sqrt{2} \times V_R \text{ (a.c.)}$
dv/dt or I_p (peak current)	$I_p = C \times dv/dt$	$dv/dt \leq \text{catalogue values}$
K_0 (energy content of the wave-form)	$K_0 = 2 \int_0^\tau (dv/dt)^2 dt$	$K_0 \leq \text{catalogue values}$
* V_{rms} and/or I_{rms} f (wave-form frequency)= $1/T$	Max dissipated power: P_{cmax}	V_{rms} vs. f (catalogue graphs) or $P_{cmax} \leq P_{clim}$ (see page 4)

* Calculated without average value (example: in case of sine wave form $V_{rms} : V_{pp} / 2 \times \sqrt{2}$)

7. Across-the-line and interference suppression applications

- 7.1 When a capacitor is used for this type of application it may be subject to a mains voltage on a permanent basis and to surges caused, for example, by lightning, power commutations etc.

In these working conditions the capacitor must be a component with a safety margin able to satisfy the main International Standards, e.g.:

- IEC 60384-14 (International Standard)
- EN 132400 (similar to the previous) (European Standard)
- UL 1414, UL 1283 (American Standards)
- CSA C22.2 Nr. 1 (Canadian Standards)

For safety reasons it is advisable to use components approved according to the above mentioned standards. *

- 7.2 Main safety tests related to IEC 60384-14 and EN132400 are listed at page 154.

* For “capacitor connected in serial with main line” (two - phase and three - phase net) application, please read the “SHORT GUIDE TO CHOOSE THE RIGHT FILM CAPACITORS” at pag. 152 and contact our Technical Service for choosing the safest solution.

8. Special working conditions

- Humid ambient.

If used for a long time in a humid ambient, the capacitor might absorb humidity and oxidise the electrodes causing breakage of the capacitor.

In case of AC application, high humidity would increase the corona effect.

This phenomenon cause a drop in the capacitance value.

In case of working condition in AC application more severe than following table, please contact our Technical Service for detailed informations.

	WORKING T°	RELATIVE HUMIDITY
AVERAGE FOR YEAR	25°C	70%
2 WKS COUNTINUOSLY	30°C	90%

- Resin.

If the capacitor is placed in resin, the following situations might occur:

- the solvent contained in the resin might deteriorate the characteristics of the capacitor;
- the heat generated during the polymerisation might damage the capacitor.

- Adhesive curing oven.

Do not place the polypropylene capacitor in the polymerisation oven of the resin used to glue SMD components: the heat combined with the length of stay in the oven might damage the dielectric of the capacitor with risk of short circuit.

When the polypropylene capacitor is used together with SMD components, always fit it after the SMD gluing process.

9. Soldering suggestions

In order to obtain a good solderability, we suggest to observe the following rules:

9.1 Max soldering temperature

Set the temperature so that inside the element the maximum temperature is below the limit:

KP/MKP	110°C
MKT	160°C

Solder within the following temperature profiles especially for iron soldering.

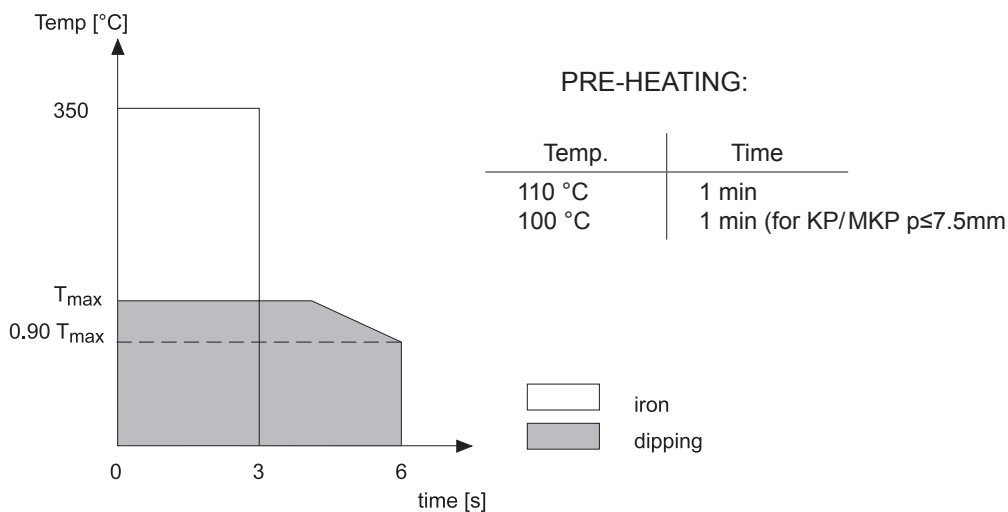

Box series: $T_{max} = 275^{\circ}\text{C}$ for 4s (260°C for 4s for MKP $p \leq 7.5\text{mm}$)

9.2 General conditions

- 9.2.1** If two solderings are needed please apply a recovery time until the temperature on the capacitor surface is below 50°C.
- 9.2.2** Avoid any passing through adhesive curing oven when fixing SMD parts in combination with leaded parts.
Insert leaded parts only after the curing of SMD parts.
- 9.2.3** Reflow: avoid reflow soldering by combining the lead type with SMD parts.

10. ROHS Compliance

In accordance with Arcotronics commitment to continuously enhance Customer satisfaction and environmental care we inform that the product series of this catalogue are from now on available in Lead Free and that they are completely in compliance with all the requirements of the EU Directives and Regulations in matter of Restriction of use of Hazardous Substances (such as 2002/95/EC, known as Rohs Directive). Unique exceptions some products that are currently manufactured with tinfoil film such as product series P12 - P14 - P42 - A72.

We can furthermore confirm that apart the termination wires (now Lead Free) no other changes were activated on our manufacturing process and that product behaviour vs. soldering processes and performances has not evidenced any difference with the one previously established and validated.

In any further detail is needed please contact us.

OTHERS

- Any buzzing noise produced by the capacitor is caused by the vibration of the film due to the Coulomb force that is generated between the electrodes with opposite poles. This buzzing noise becomes louder if a wave-form with a high distortion rate or frequency is applied across the capacitor. This buzzing noise is of no damage to the capacitor.
 - The capacitor modifies its characteristics according to the ambient conditions in which it operates. In normal conditions a variation in the capacitance takes place due to the amount of humidity contained in the air. The variation mainly depends upon the type of dielectric and the material used for the coating.
 - Avoid to store the capacitors in places where the conditions differ from the following:
 - * Storage time: ≤ 24 months from the date marked on the label glued to the package.
 - * Temperature: -40 to 80°C
 - * Humidity:
 - Average per year: $\leq 70\%$
 - For 30 full days randomly distributed throughout the year: $\leq 85\%$
 - Dew: absent.
- These levels of humidity must be reduced according to the ambient temperature on the basis of the graph that follows.

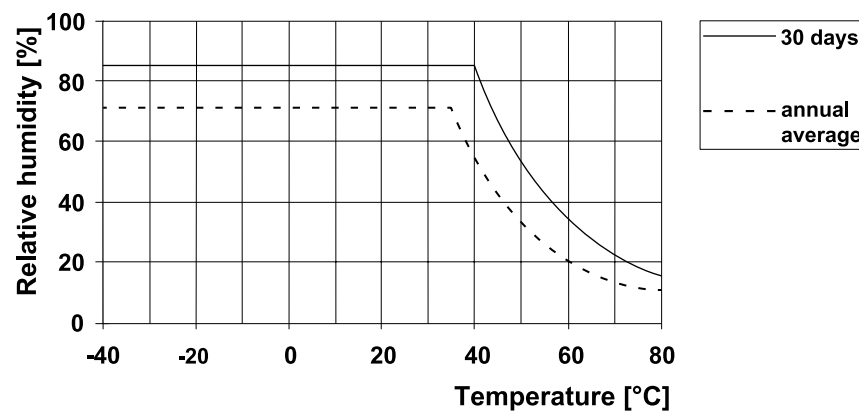
MAX. HUMIDITY

TYPICAL PROPERTIES AND APPLICATIONS

POLYESTER FILM

Typical properties:

- very wide operating temperature range
- high dielectric constant
- Excellent self-healing properties
- very good ratio box size/capacitance
- good stability

Typical Applications

- blocking and coupling
- by-passing
- decoupling
- low filtering
- timing
- market sector with professional characteristics

POLYPROPYLENE FILM

Typical properties:

- very low dissipation factor
- very low dielectric absorption
- very high insulation resistance
- good behaviour in frequency
- Excellent self-healing properties. (MKP type)
- very good stability

Typical Applications

- pulse applications
- high current
- A.C. applications
- timing with high stability
- SMPS and TV set
- lighting
- industrial
- filtering high Q

DIELECTRIC ABSORPTION (DA)

Typical value:

Polyester : 0.5%
Polypropylene: 0.05%

TYPICAL GRAPHS:

————— Polyester

----- Polypropylene

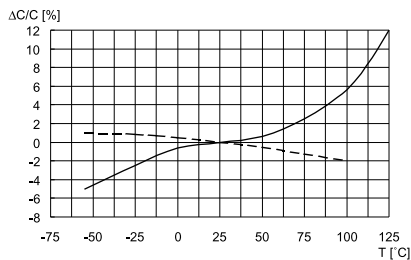

Capacitance change vs. temperature at 1kHz

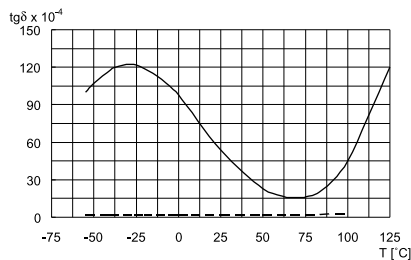

Dissipation factor vs. temperature at 1kHz

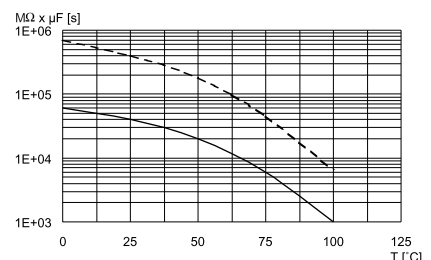

Time constant vs. temperature

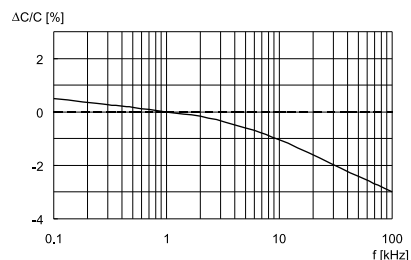

Capacitance change vs. frequency (Room temperature)

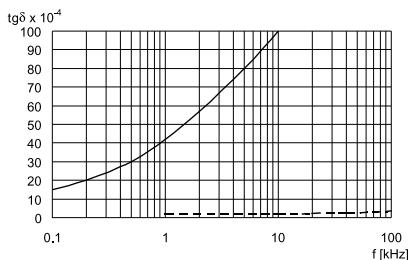

Dissipation factor vs. frequency (Room temperature)

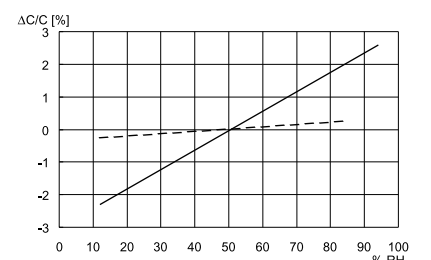

Capacitance change vs. relative humidity (RH)

PRODUCT CODE SYSTEM AND DATE CODE: BOX AND AXIAL SERIES

PRODUCT CODE SYSTEM

The part number, comprising 14 digits, is formed as follows:



DATE CODE (according to EN60062)

Year	Code letter	Month	Code letter
1998	K	January	1
1999	L	February	2
2000	M	March	3
2001	N	April	4
2002	P	May	5
2003	R	June	6
2004	S	July	7
2005	T	August	8
2006	U	September	9
2007	V	October	O
2008	W	November	N
2009	X	December	D

Digit 1 to 3 Series code.

Digit 4 d.c. or a.c. rated voltage

*A = 310Vac	I = 250Vdc	P = 630Vdc	U = 2000Vdc	3 = 300Vac
C = 50 Vdc	K = 275Vac	Q = 1000Vdc	V = 520Vdc	4 = 440Vac
D = 63Vdc	L = 250Vac	R = 1250Vdc	W = 500Vdc	*5 = 500Vac
E = 100Vdc	*M = 400Vdc	S = 1500Vdc	X = 450Vdc	7 = 700Vac
G = 160Vdc	N = 400Vac	T = 1600Vdc	2 = 230Vac	9 = 900Vac

(*M = 420 Vdc for R71 Series only) - (*5 = 520 Vac for R475 Series only) - (*A = 330 Vac for R49 Series only)

Digit 5 Pitch (mm) of radial capacitors or length of axial capacitors (**for Polyester, Polypropylene and Suppressor caps**)

C = 5.0	F = 10/11	I = 15/16.5	N = 22.5	R = 27.5	W = 37.5
D = 7.5	H = 14	K = 20.5	Q = 28.0	T = 33.0	

Digit 5 Dimensions (BxHxL in mm) of capacitors (**for Precision caps**).

M = 5.0x 11.0x6.3	C = 10.0x10.0x13.0
A = 6.25x6.25x11.0 (100 pF to 5 kpF KP)	D = 12.5x12.5x13.0
(5 kpF to 75 kpF MKP)	Z = Special dimensions
W = 6.25x6.25x11.0 (5 kpF to 9.2 kpF KP)	P A.48 Series
B = 7.5x7.5x13.0 (100 pF to 21 kpF KP)	
I = 7.5x7.5x13.0 (5 kpF to 21 kpF MKP)	

Digit 6 to 9 Digits 7 - 8 - 9 indicate the first three digits of Capacitance value and the 6th digit indicates the number of zeros that must be added to obtain the Rated Capacitance in pF (**for Polyester, Polypropylene and Suppressor caps**).

Digit 6 to 9 Indicate the Arcotronics internal capacitance code (**for Precision caps**).

Digit 10 to 11 Mechanical version and/or packaging: see the pages related to each series.

Digit 12 Identifies the dimensions and electrical characteristics

Digit 13 Internal use.

Digit 14 Capacitance tolerance

Code letter	Z	D	P	F	A	L	G	H	J	K	M
Capacitance tolerance	± 1pF	0.5%	0.625%	1%	1.25%	1.5%	2%	2.5%	5%	10%	20%

Code example: R82 Series (Polyester Radial)

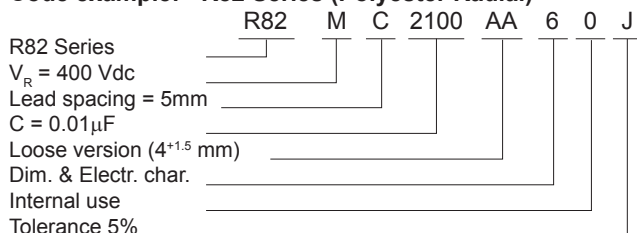

LEAD TAPING AND PACKAGING

LEAD TAPING AND PACKAGING OF AXIAL COMPONENTS FOR AUTOMATIC AND ROBOT INSERTION MACHINES

Technical terms: IEC 60286-1

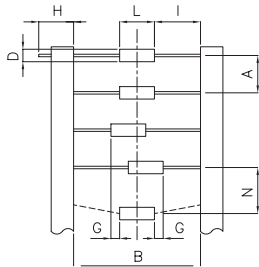

Packaging detail
Available reel Ø 355 mm only.
Reel

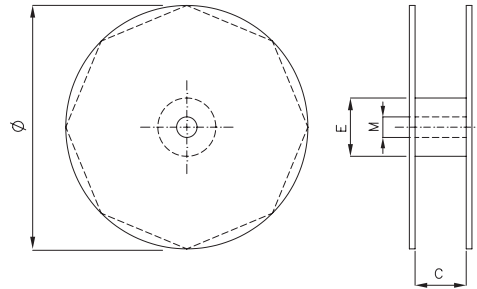

Description	Symbol	Dimensions (mm)
Component diameter	D	4.5 ... 19.5
Body length	L	11 ... 33
Component pitch	A*	See table I
Reel core diameter	E	85
Arbor hole diameter	M	30
Reel diameter	Ø	355 max.
Tape width	H	6±0.5/9±1**
Body location (lateral deviation)	G	≤ 0.7
Body location (longitudinal deviation)	N	≤ 1.2
Tape spacing	B	See Table II
Lead length from the component body to the adhesive tape	I	≥ 20
Distance between reel flanges	C	See table II

Table I

D max (mm)	A (mm)
≤ 5	5 ±0.5
5.1 ... 9.5	10 ±0.5
9.6 ... 14.7	15 ±0.5
14.8 ... 19.5	20 ±1.0

Table II

L max (mm)	Class	B±1.5 (mm)	C (mm)
≤1	I	52.4	75
14.0 ... 20.5	II	63.6	86
≥26	III	73.0	98

Remarks

* Cumulative pitch tolerance must not exceed 1.5 mm over six consecutive components.

** 9±1 for capacitor with L≥31.5

NUMBER OF PIECES FOR PACKING UNIT

D max (mm)	L max (mm)	Loose* (pcs)	Reel Ø 355mm (pcs)
5	11	1500	3000
5.1 ... 5.5	11	1500	1500
5.6 ... 6.5	11	1200	1300
6.6 ... 7.0	11.0 ... 16.5	1750	1100
7.1 ... 7.5	11.0 ... 16.5	1500	1000
7.6 ... 8.0	11.0 ... 16.5	1250	900
8.1 ... 9.5	11.0 ... 16.5	1000	800
5.0 ... 6.0	14.0 ... 16.5	2000	1300
6.1 ... 6.5	14.0 ... 16.5	2000	1200
5.5 ... 6.0	20.5	1500	1300
6.1 ... 6.5	20.5	1250	1200
6.6 ... 7.0	20.5	1250	1100
7.1 ... 7.5	20.5	1000	1000
7.6 ... 8.0	20.5	1000	900
8.1 ... 9.0	20.5	750	800
9.1 ... 10.0	20.5	750	600
10.1 ... 11.5	20.5	500	400
7.0 ... 7.5	28.0	750	1000
7.6 ... 8.0	28.0	500	900
8.1 ... 9.0	28.0	500	800
9.1 ... 10.0	28.0	500	600
10.1 ... 11.0	28.0	500	400
11.1 ... 13.0	28.0	300	400
13.1 ... 15.0	28.0	300	300
15.1 ... 16.5	28.0	300	250

NUMBER OF PIECES FOR PACKING UNIT

D max (mm)	L max (mm)	Loose* (pcs)	Reel Ø 355mm (pcs)
10.0 ... 11.5	33.0	400	400
11.6 ... 13.0	33.0	300	400
13.1 ... 15.0	33.0	300	300
15.1 ... 16.5	33.0	200	250
16.6 ... 18.0	33.0	200	200
18.1 ... 20.0	33.0	150	150
20.1 ... 26.4	33.0	100	

*Loose version: lead length = 40±5 mm

°*Loose version: lead length = 40±5 mm

LEAD TAPING AND PACKAGING OF RADIAL COMPONENTS FOR AUTOMATIC INSERTION MACHINES

Technical terms: IEC 60286-2

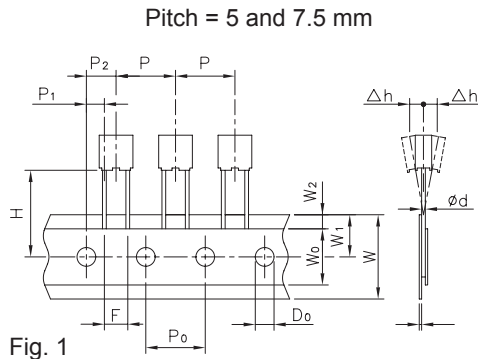

Fig. 1

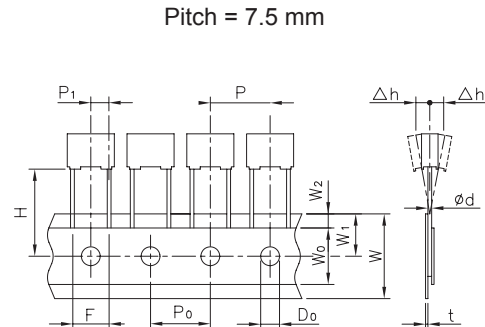
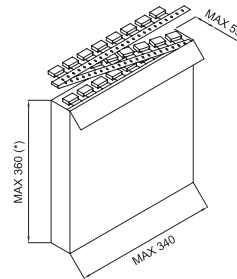

Fig. 2

Packaging detail

Two different containers are available:
Fan-fold box (Ammo-pack)
Reel Ø 355 mm only.

Ammo-pack (dimensions in mm)



* Lower dimension available
* upon request (max. 295mm)

Reel (dimensions in mm)

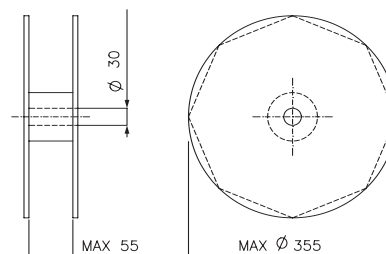

Description	Symbol	Dimensions (mm)			Tol.
		Pitch			
		5 mm Fig.1	7.5 mm Fig.1	7.5 mm Fig. 2	
Lead wire diameter	d	0.5 ... 0.6	0.5 ... 0.6	0.5 ... 0.6	±0.05
Taping pitch	P	12.7	12.7	12.7	±1
Feed hole pitch	P ₀	12.7	12.7	12.7	±0.2*
Centering of the lead wire	P ₁	3.85	2.6	3.75	±0.7
Centering of the body	P ₂	6.35	6.35		±1.3
Lead spacing (pitch)	F	5	7.5	7.5	+0.6 -0.1
Component alignment	Δh	0	0	0	±2
Height of component from tape center	H**	18.5	18.5	18.5	±0.5
Carrier tape width	W	18	18	18	+1 -0.5
Hold down tape width	W ₀	6	6	6	min.
Hole position	W ₁	9	9	9	±0.5
Hold down tape position	W ₂	3	3	3	max.
Feed hole diameter	D ₀	4	4	4	±0.2
Tape thickness	t	0.7	0.7	0.7	±0.2

Remarks

* Max 1mm on 20 pitches

** H = 16.5 mm is available upon request.

For orders of capacitors with pitch = 7.5 mm, please specify the requested version (fig.1 or fig.2).

NUMBER OF PIECES FOR PACKING UNIT

Box dimensions			Pitch	Loose *short leads	Loose **long leads	Ammo	Reel Ø355mm
B	H	L					
(mm)	(mm)	(mm)	(mm)	(pcs)	(pcs)	(pcs)	(pcs)
2.5	6.5	7.2	5.0	3000	4000	3500	2500
3.5	7.5	7.2	5.0	2000	3000	2500	1800
4.5	9.5	7.2	5.0	1500	2000	1900	1400
5.0	10.0	7.2	5.0	1000	1500	1700	1200
6.0	11.0	7.2	5.0	2000	1000	1400	1000
7.2	13.0	7.2	5.0	1500	750	1150	800

Box dimensions			Pitch	Loose *short leads	Loose **long leads	Ammo	Reel Ø355mm
B	H	L					
(mm)	(mm)	(mm)	(mm)	(pcs)	(pcs)	(pcs)	(pcs)
2.5	7.0	10.0	7.5	2000	2500	3400	2500
3.0	8.0	10.0	7.5	1500	1500	2800	2100
3.5	6.5	10.5	7.5	2500	1500	2500	1800
3.5	8.5	10.5	7.5	3000	1300	2450	1800
4.0	9.0	10.5	7.5	2000	1300	2100	1500
5.0	11.0	10.5	7.5	1500	1000	1600	1200
6.0	12.0	10.5	7.5	1000	700	1400	1000

* Short leads: lead length = 4^{+1.5} mm (pitch = 5mm); 4⁺² mm (pitch = 7.5mm)

** Long leads: lead length = 17^{+1/-2} mm

LEAD TAPING AND PACKAGING OF RADIAL COMPONENTS FOR ROBOT INSERTION MACHINES

Technical terms: IEC 60286-2

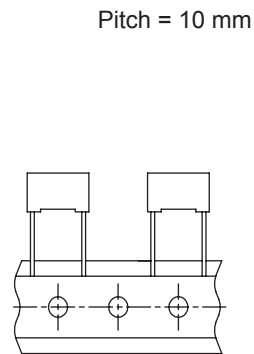

Fig. 1

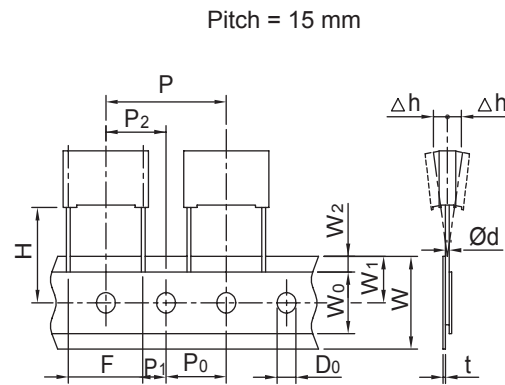

Fig. 2

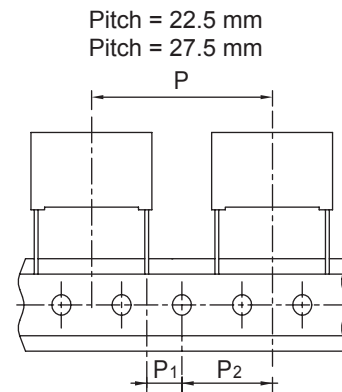

Fig. 3

Description	Symbol	Dimensions (mm)					Tol.
		Pitch					
		10 mm Fig.1	15 mm Fig.2	22.5mm Fig.3	27.5mm Fig.3		
Lead wire diameter	d	0.6	0.6/0.8	0.8	0.8	±0.05	
Taping pitch	P	25.4	25.4	38.1	38.1	±1	
Feed hole pitch*	P ₀	12.7	12.7	12.7	12.7	±0.2**	
Centering of the lead wire	P ₁	7.7	5.2	7.8	5.3	±0.7	
Centering of the body	P ₂	12.7	12.7	19.05	19.05	±1.3	
Lead spacing (pitch) ***	F	10	15	22.5	27.5	+ 0.6 - 0.1	
Component alignment	Δh	0	0	0	0	±2	
Height of component from tape center	H****	18.5	18.5	18.5	18.5	±0.5	
Carrier tape width	W	18	18	18	18	+1-0.5	
Hold down tape width	W ₀	9	10	10	10	min.	
Hole position	W ₁	9	9	9	9	±0.5	
Hold down tape position	W ₂	3	3	3	3	max.	
Feed hole diameter	D ₀	4	4	4	4	±0.2	
Tape thickness	t	0.7	0.7	0.7	0.7	±0.2	

Remarks

* Available also 15mm.

** Max 1mm on 20 pitches.

*** Pitches 15mm and 10mm taped to 7.5mm (crimped leads) available upon request.

**** H = 16.5 mm is available upon request.

Packaging detail

Two different containers are available: fan-fold box (ammo-pack) and reel:

Ammopack (dimensions in mm)

for pitch ≤ 22.5 mm

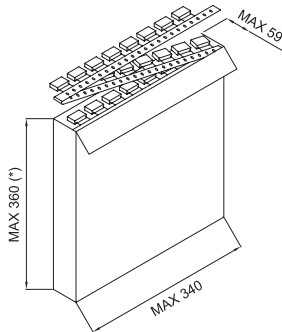

Reel (dimensions in mm)

\varnothing 355 mm for pitch ≤ 15 mm
 \varnothing 500 mm for pitch ≥ 10 mm

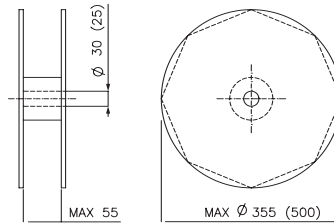

* Lower dimension available
 * upon request (max. 295mm)

NUMBER OF PIECES FOR PACKING UNIT

Box dimensions			Pitch (mm)	Loose *short leads (pcs)	Loose **long leads (pcs)	Ammo (pcs)	Reel \varnothing 355mm (pcs)	Reel \varnothing 500mm (pcs)
B (mm)	H (mm)	L (mm)						
4.0	9.0	13.0	10.0	2000	1800	1000	750	1500
5.0	11.0	13.0	10.0	1300	1500	800	600	1250
6.0	12.0	13.0	10.0	1000	1200	680	500	1000
4.0	10.0	18.0	15.0	2500	1500	1000		1500
5.0	11.0	18.0	15.0	2000	1000	800	600	1250
6.0	12.0	18.0	15.0	1750	900	680	500	1000
7.5	13.5	18.0	15.0	1000	700	500	350	800
6.0	17.5	18.0	15.0	1000	700	680		
7.5	14.5	18.0	15.0	1000	700	500	350	800
8.5	14.5	18.0	15.0	1000	500	440	300	700
9.0	12.5	18.0	15.0	1000	520	410	270	650
7.5	18.5	18.0	15.0	900	500			800
10.0	16.0	18.0	15.0	750	500	380	300	600
13.0	12.0	18.0	15.0	750	490	280	200	480
11.0	19.0	18.0	15.0	450	350	340		500
6.0	15.0	26.5	22.5	805	500	464		700
7.0	16.0	26.5	22.5	700	500	380		550
8.5	17.0	26.5	22.5	468	300	280		450
10.0	18.5	26.5	22.5	396	300	235		350
11.0	20.0	26.5	22.5	360	250	217		350
13.0	22.0	26.5	22.5	300	200			300

Box dimensions			Pitch (mm)	Loose *short leads (pcs)	Loose **long leads (pcs)	Ammo (pcs)	Reel \varnothing 355mm (pcs)	Reel \varnothing 500mm (pcs)
B (mm)	H (mm)	L (mm)						
9.0	17.0	32.0	27.5	816	408			450
10.0	20.0	32.0	27.5	600	408			350
11.0	20.0	32.0	27.5	560	336			350
13.0	22.0	32.0	27.5	480	288			300
13.0	25.0	32.0	27.5	480	288			
14.0	28.0	32.0	27.5	352	176			
15.0	24.5	32.0	27.5	400	240			
18.0	33.0	32.0	27.5	256	128			
22.0	37.0	32.0	27.5	168	112			
11.0	22.0	41.5	37.5	420	252			
13.0	24.0	41.5	37.5	360	216			
16.0	28.5	41.5	37.5	216	108			
19.0	32.0	41.5	37.5	192	96			
20.0	40.0	41.5	37.5	126	84			
24.0	44.0	41.5	37.5	108	72			
30.0	45.0	41.5	37.5	90	60			

* Short leads: lead length= 4^{+2} mm
 ** Long leads: lead length= $25^{+2/-1}$ mm

**LEAD TAPING AND PACKAGING OF RADIAL COMPONENTS FOR ROBOT INSERTION MACHINES
(PRECISION CAPACITORS: P.12, P.14 AND P.42 SERIES)**

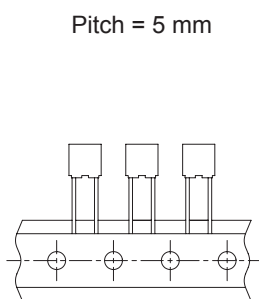

Fig. 1

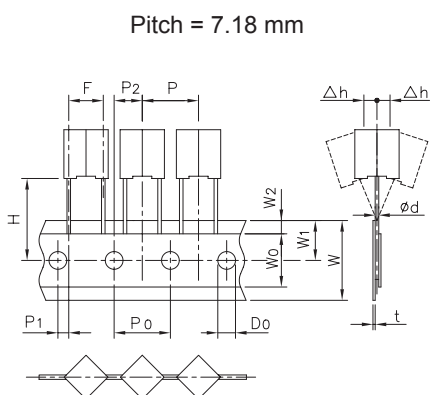

Fig. 2

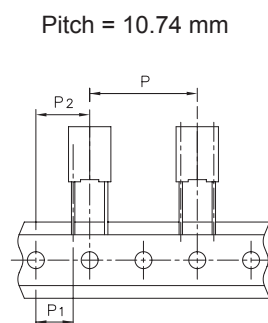

Fig. 3

Description	Symbol	Dimensions (mm)			Tol.
		Pitch			
		5 mm Fig.1	7.18 mm Fig. 2	10.74 mm Fig. 3	
Lead wire diameter	d	0.5 ... 0.6	0.5 ... 0.6	0.6	±0.05
Taping pitch	P	12.7	12.7	25.4	±1
Feed hole pitch	P ₀	12.7	12.7	12.7	±0.2*
Centering of the lead wire	P ₁	3.85	2.76	7.33	±0.7
Centering of the body	P ₂	6.35	6.35	12.7	±1.3
Lead spacing (pitch)	F	5	7.18	10.74	+0.6/-0.1
Component alignment	Δh	0	0	0	±2
Height of component from tape center	H	18.5**	18.5**	16.5	±0.5
Carrier tape width	W	18	18	18	+1/-0.5
Hold down tape width	W ₀	6	6	6	min.
Hole position	W ₁	9	9	9	±0.5
Hold down tape position	W ₂	3	3	3	max.
Feed hole diameter	D ₀	4	4	4	±0.2
Tape thickness	t	0.7	0.7	0.7	±0.2

Remarks

* Max 1mm on 20 pitches

** H = 16.5 mm is available upon request.

NUMBER OF PIECES FOR PACKING UNIT

Box dimensions			Pitch (mm)	Loose standard leads* (pcs)	Reel Ø355mm (pcs)	Reel Ø500mm (pcs)
B (mm)	H (mm)	L (mm)				
5.0	11.0	6.3	5.0	1800	1250	500
6.25	6.25	11.0	7.18	1500	700	
7.5	7.5	13.0	7.18	1000	600	
10.0	10.0	13.0	10.74	600		
12.5	12.5	13.0	14.3	400		

* Standard leads: see the pages related to each series.

Packaging detail

Pitch 5 and 7.18 mm: reel Ø 355 mm only
Pitch 10.74 mm: reel Ø 500 mm only

Reel (dimensions in mm)

